

MI-ComPAC™

Military DC-DC Power Supplies



Product Highlights

The MI-ComPAC is a complete single, dual, or triple output DC-DC power supply that delivers up to 300W from inputs of 28Vdc or 270Vdc.

The MI-ComPAC meets the conducted emissions and conducted susceptibility specifications of MIL-STD-461C/D/E and offers complete input transient, surge, and spike protection to the most severe levels of MIL-STD-1275A, 704A.

Reverse polarity protection and over/undervoltage lockout provide additional safeguards against potentially damaging line conditions. The MI-ComPAC also features a master disable.

Features

- ✦ Inputs: 28Vdc per MIL-STD-704A, MIL-STD-1275A
270Vdc per MIL-STD-704D/E
- ✦ Outputs: 1 to 3, 2 to 48Vdc
- ✦ Up to 5W/in³
- ✦ MIL-STD-461C/D/E EMI compliance
- ✦ High efficiency
- ✦ Remote sense
- ✦ ZVS/ZCS power architecture
- ✦ Low noise FM control
- ✦ Reverse polarity protection
- ✦ Size — 1- up: 8.6" x 2.5" x 0.99" (219,2 x 64,5 x 25,1mm)
- ✦ Size — 2- up: 8.6" x 4.9" x 0.99" (219,2 x 126,0 x 25,1mm)
- ✦ Size — 3- up: 8.6" x 7.3" x 0.99" (219,2 x 187,45 x 25,1mm)

Configuration Chart

Configuration	Power Range	Dimensions	Number of Modules
Single Output			
MI-LC [] - [] []	50 – 100W	8.6" x 2.5" x 0.99"	1
MI-MC [] - [] [] []	150 – 200W	8.6" x 4.9" x 0.99"	2
MI-NC [] - [] [] []	300W	8.6" x 7.3" x 0.99"	3
Dual Output			
MI-PC [] [] - [] [] [] []	100 – 200W	8.6" x 4.9" x 0.99"	2
MI-QC [] [] - [] [] [] []	200 – 300W	8.6" x 7.3" x 0.99"	3
Triple Output			
MI-RC [] [] [] - [] [] [] [] []	150 – 300W	8.6" x 7.3" x 0.99"	3

Conduction Cooled Models Available Add "-CC" to the end of the part number.
(Consult factory for details.)

Input Voltage	Output Voltage	Product Grade																																				
Nominal Range 2 = 28Vdc 18 – 50V 6 = 270Vdc 125 – 400V ⁽¹⁾	Z = 2V T = 6.5V N = 18.5V Y = 3.3V R = 7.5V 3 = 24V 0 = 5V M = 10V L = 28V X = 5.2V 1 = 12V J = 36V W = 5.5V P = 13.8V K = 40V V = 5.8V 2 = 15V 4 = 48V	I = -40°C to +85°C M = -55°C to +85°C																																				
Output Power/Current	Output Power/Current	Output Power/Current																																				
<table border="1"> <thead> <tr> <th></th> <th>≥5V</th> <th><5V</th> </tr> </thead> <tbody> <tr> <td>Y</td> <td>50W</td> <td>10A</td> </tr> <tr> <td>X</td> <td>75W</td> <td>15A</td> </tr> <tr> <td>W</td> <td>100W</td> <td>20A</td> </tr> <tr> <td>V</td> <td>—</td> <td>30A</td> </tr> </tbody> </table>		≥5V	<5V	Y	50W	10A	X	75W	15A	W	100W	20A	V	—	30A	<table border="1"> <thead> <tr> <th></th> <th>≥5V</th> <th><5V</th> </tr> </thead> <tbody> <tr> <td>V</td> <td>150W</td> <td>30A</td> </tr> <tr> <td>U</td> <td>200W</td> <td>—</td> </tr> <tr> <td>S</td> <td>—</td> <td>60A</td> </tr> </tbody> </table>		≥5V	<5V	V	150W	30A	U	200W	—	S	—	60A	<table border="1"> <thead> <tr> <th></th> <th>≥5V</th> <th><5V</th> </tr> </thead> <tbody> <tr> <td>S</td> <td>300W</td> <td>—</td> </tr> <tr> <td>P</td> <td>—</td> <td>90A</td> </tr> </tbody> </table>		≥5V	<5V	S	300W	—	P	—	90A
	≥5V	<5V																																				
Y	50W	10A																																				
X	75W	15A																																				
W	100W	20A																																				
V	—	30A																																				
	≥5V	<5V																																				
V	150W	30A																																				
U	200W	—																																				
S	—	60A																																				
	≥5V	<5V																																				
S	300W	—																																				
P	—	90A																																				

⁽¹⁾ These units rated at 75% load from 125-150Vin: 5Vout @ 100W; 2Vout and 3.3Vout @ 30A.

Specifications

(At $T_{BP} = 25^{\circ}\text{C}$, nominal line and 75% load, unless otherwise specified)

PARAMETER	MIN	TYP	MAX	UNITS	NOTES
Input Characteristics					
28Vdc input modules					
Steady state input	18	28	50	Vdc	
Low line lockout			16	Vdc	Automatic recovery
Input spike limit	-600		+600	Vdc	20 μs , 50 Ω per MIL-STD-704A
	-250		+250	Vdc	100 μs , 15mJ per MIL-STD-1275A
Input surge limit			100	Vdc	60mS, 0.5 Ω per MIL-STD-1275A
Overvoltage shutdown	50			Vdc	100mS automatic recovery
Reverse polarity protection					Shunt diode: input fuse required
Recommended fuse			10 ⁽¹⁾	Amps	F03A type
270Vdc input modules					
Steady state input	125	270	400	Vdc	
Low line lockout			125	Vdc	Automatic recovery
Input spike limit			+800	Vdc	20 μs , 50 Ω
	-600		+600	Vdc	100 μs , 15mJ
Input surge limit			500	Vdc	100ms, 0.5 Ω
Overvoltage shutdown	400			Vdc	100 μs automatic recovery
Reverse polarity protection					Shunt diode: input fuse required
Recommended fuse			2 ⁽¹⁾	Amps	F03A type
All models					
No load power dissipation		1.5 ⁽¹⁾	2 ⁽¹⁾	Watts	
Master disable input current ⁽²⁾ (Absolute max., 20mA)	4			mA	Sink; disables all outputs
Inrush current		110	125	%, I_{in}	Steady state I_{in} , 10ms
EMC Characteristics; MIL-STD-461C/D/E					
Input power leads					
Conducted emissions	CE01, CE03, CE07 CE101, CE102 CE101				MIL-STD-461C — 1-up MIL-STD-461D — 1-up MIL-STD-461E — 2-up & 3-up
Conducted susceptibility	CS01, CS02, CS06 CS101, CS114, CS116 CS101, CS114, CS116				MIL-STD-461C — 1-up MIL-STD-461D — 1-up MIL-STD-461E — 2-up & 3-up
Output Characteristics					
Setpoint accuracy		0.5	1.0	% V_{nom}	
Load/line regulation		0.2	0.5	% V_{nom}	LL to HL, NL to 10% LL to HL, 10% to FL
		0.05	0.2	% V_{nom}	
Output temperature drift		0.01	0.02	%/ $^{\circ}\text{C}$	
Output noise – p-p		1.0	1.5	% V_{nom}	Whichever is greater 20MHz BW
		100	150	mV	
Output voltage trimming ⁽³⁾	50		110	% V_{nom}	
Remote sense compensation	0.5			Vdc	
OVP setpoint	115	125	135	% V_{nom}	Latching
Current limit	105		125	% I_{nom}	Auto restart
Short circuit current ⁽⁴⁾	20		130	% I_{nom}	
Isolation Characteristics					
Input to output	4,242			Vrms	1 min.
Input to case					
28Vdc input	2,121			Vrms	1 min.
270Vdc input	2,500			Vrms	1 min.
Output to case	500			Vrms	1 min.
Thermal Characteristics					
Efficiency		81		%	
Operating temperature, case			+85	$^{\circ}\text{C}$	See product grade
Storage temperature			+100	$^{\circ}\text{C}$	See product grade
Shutdown temperature	+90	+95	+105	$^{\circ}\text{C}$	Cool and recycle power to restart
Mechanical Specifications					
Weight					
1-up		1.2 (544)		pounds (grams)	
2-up		2.4 (1248)		pounds (grams)	
3-up		3.6 (1633)		pounds (grams)	
Connector screw torque		3.5 (0.4)		inches-pounds (N-M)	

⁽¹⁾ Per internal module configuration.

⁽²⁾ Multiply minimum x 2 for 2-ups and x 3 for 3-ups.

⁽³⁾ 10V, 12V, and 15V outputs, standard trim range $\pm 10\%$. Consult factory for wider trim range.

⁽⁴⁾ Output ranges of 5V or less incorporate foldback current limiting, outputs of 10V and above incorporate straight line current limiting.

Long Term Safe Operating Area Curves*

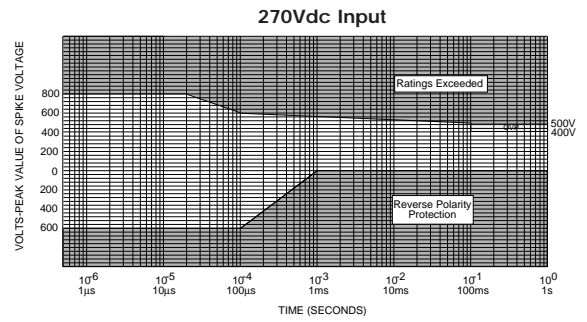
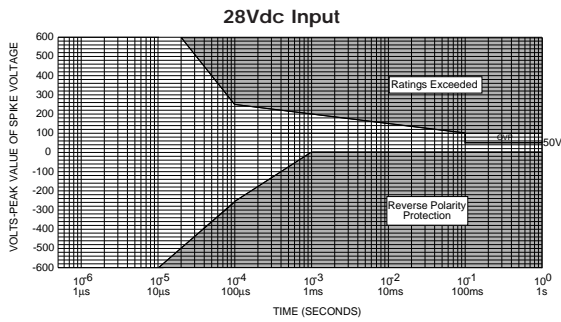

* 1% duty cycle max., for short duration transient capability refer to specifications

Disable Circuit

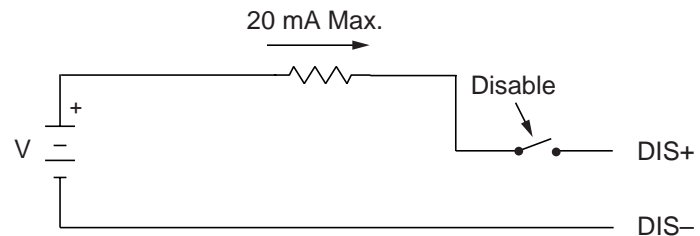

Disable Current

- 4mA DC minimum for 1-up ComPAC
- 8mA DC minimum for 2-up ComPAC
- 12mA DC minimum for 3-up ComPAC

The MI-ComPAC incorporates an optically isolated master disable input which will shut down the MI-ComPAC when a current is driven through the disable terminals.

Thermal Considerations

Thermal Impedance — Case-to-Air (°C/W)

	Standard Units			With Optional Heat Sink ⁽¹⁾		
	1-up	2-up	3-up	1-up	2-up	3-up
Free Air (Horiz.)	3.6	1.7	1.4	2.1	1.3	1.0
Forced Convection Through Heat Sink Fins						
50 LFM	2.7	1.4	1.3	1.5	1.1	0.9
100 LFM	2.3	1.3	1.1	1.2	0.9	0.7
250 LFM	1.6	1.0	0.8	0.7	0.5	0.4
500 LFM	1.2	0.7	0.6	0.4	0.3	0.3
750 LFM	0.9	0.5	0.5	0.3	0.2	0.2
1000 LFM	0.8	0.4	0.4	0.2	0.2	0.2

- Thermal impedance, chassis-to-air, is provided for 1-up, 2-up and 3-up MI-ComPAC package configurations as a function of air flow.
- Case temperature = (total power dissipated x thermal impedance) + ambient temperature.
- Watts dissipated per output = (output power ÷ efficiency) – output power.

⁽¹⁾ To order optional heat sink add -H1 to part number

Inputs

Outputs

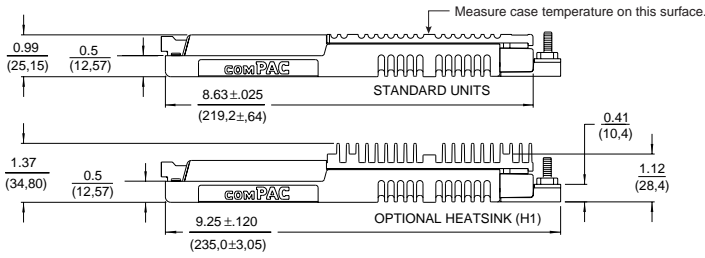

1-Up

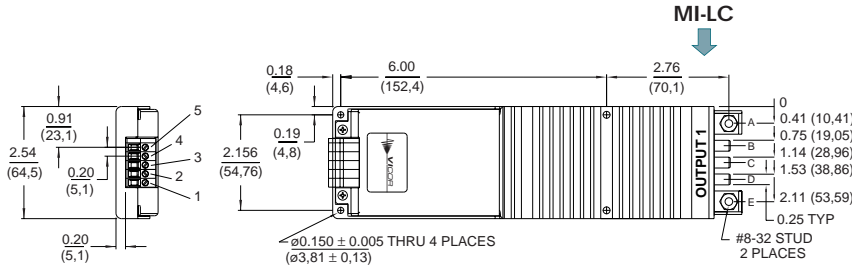

2-Up

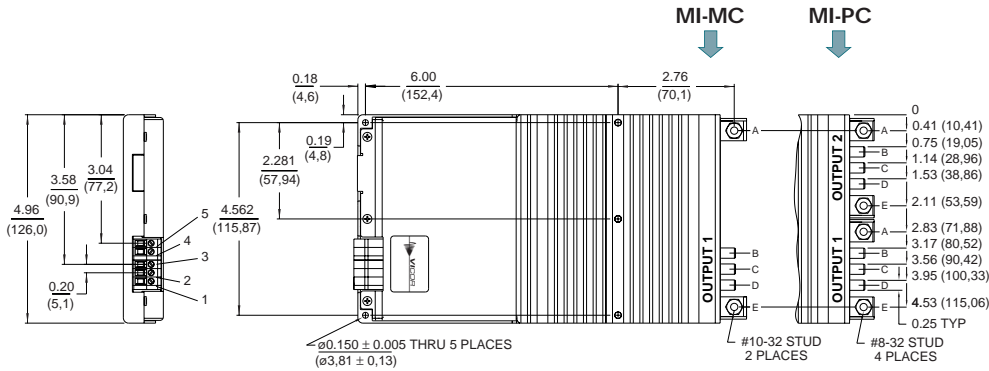

3-Up

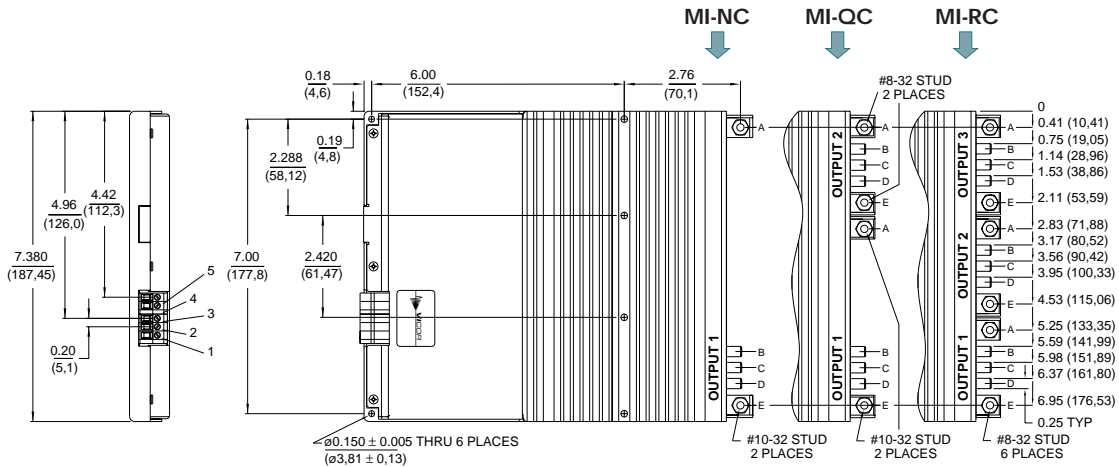

Inputs

- 1 -Ground
- 2 -Input
- 3 +Input
- 4 Disable-
- 5 Disable+

Outputs

- | | | |
|-----------|-----------|-----------|
| Output #1 | Output #2 | Output #3 |
| A +Output | A +Output | A +Output |
| B +Sense | B +Sense | B +Sense |
| C Trim | C Trim | C Trim |
| D -Sense | D -Sense | D -Sense |
| E -Output | E -Output | E -Output |