

## WIDEBAND FIXED ATTENUATOR FAMILY, DC - 25 GHz HMC656LP2E / HMC657LP2E / HMC658LP2E

### Typical Applications

The HMC656LP2E - HMC658LP2E are ideal for:

- Fiber Optics
- Microwave Radio
- Military & Space
- Test & Measurement
- Scientific Instruments
- RF / Microwave Circuit Prototyping

### Features

- 3 Attenuator Products:  
10, 15, & 20 dB Fixed Attenuation Levels
- Wide Bandwidth: DC - 25 GHz
- Excellent Attenuation Accuracy
- Power Handling: +25 dBm
- 6 Lead 2x2mm SMT Package: 4mm<sup>2</sup>

### Functional Diagrams

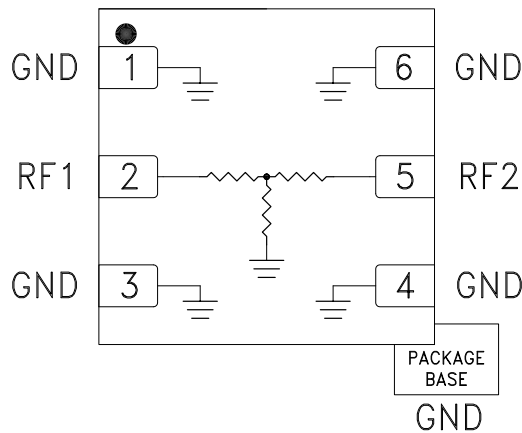

### General Description

The HMC656LP2E / 657LP2E / 658LP2E are a line of wideband fixed value SMT 50 Ohm matched attenuators which offer relative attenuation levels of 10, 15 and 20 dB respectively. These passive attenuators are ideal for military, test equipment, and other wideband applications where extremely flat attenuation, and excellent VSWR vs. frequency are required.

These wideband attenuators handle up to +25 dBm of input power, and are compatible with high volume surface mount manufacturing techniques.

### Electrical Specifications, $T_A = +25^\circ\text{C}$ , 50 Ohm system

Part Number	Attenuator Value	Return Loss (Typical)	Attenuation Tolerance <sup>[1]</sup>	Temperature Coefficient (Typical) <sup>[2]</sup>	Units
					DC - 25
HMC656LP2E	10	12	± 1.5	0.0004	dB
HMC657LP2E	15	14	± 2.0	0.0006	dB
HMC658LP2E	20	12	± 2.0	0.0004	dB

[1] Attenuation Tolerance is valid over temperature.

[2] Temperature Coefficient Units are dB/ °C.

## WIDEBAND FIXED ATTENUATOR FAMILY, DC - 25 GHz HMC656LP2E / HMC657LP2E / HMC658LP2E

**Attenuation vs. Temperature**

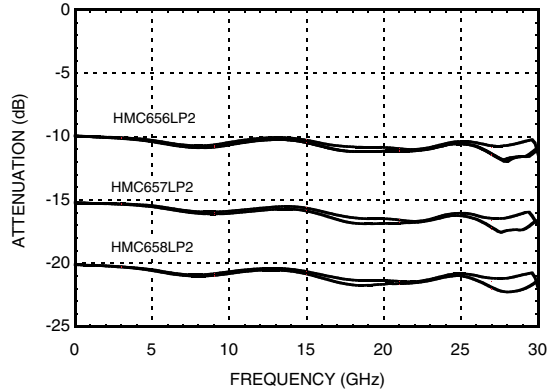

**Return Loss**

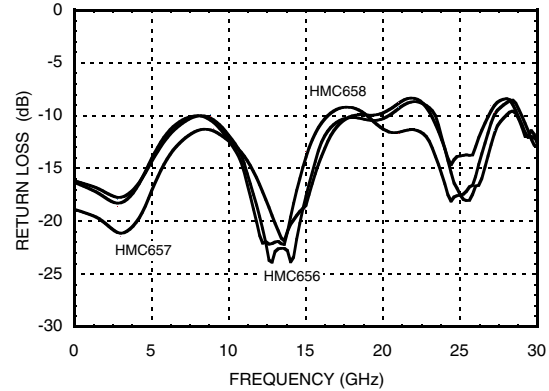

**Absolute Maximum Ratings**

Part Number	HMC656LP2E	HMC657LP2E	HMC658LP2E	Units
RF Input Power (CW)	25	25	25	dBm
DC Voltage Terminated	4.9	4.4	4.8	V
DC Voltage Open	5.3	4.6	4.9	V
Storage Temperature	-65 to +150			°C
Operating Temperature	-40 to +85			°C
ESD Sensitivity (HBM)	Class 1B	Class 1B	Class 1B	



ELECTROSTATIC SENSITIVE DEVICE  
OBSERVE HANDLING PRECAUTIONS

## WIDEBAND FIXED ATTENUATOR FAMILY, DC - 25 GHz HMC656LP2E / HMC657LP2E / HMC658LP2E

### Outline Drawing

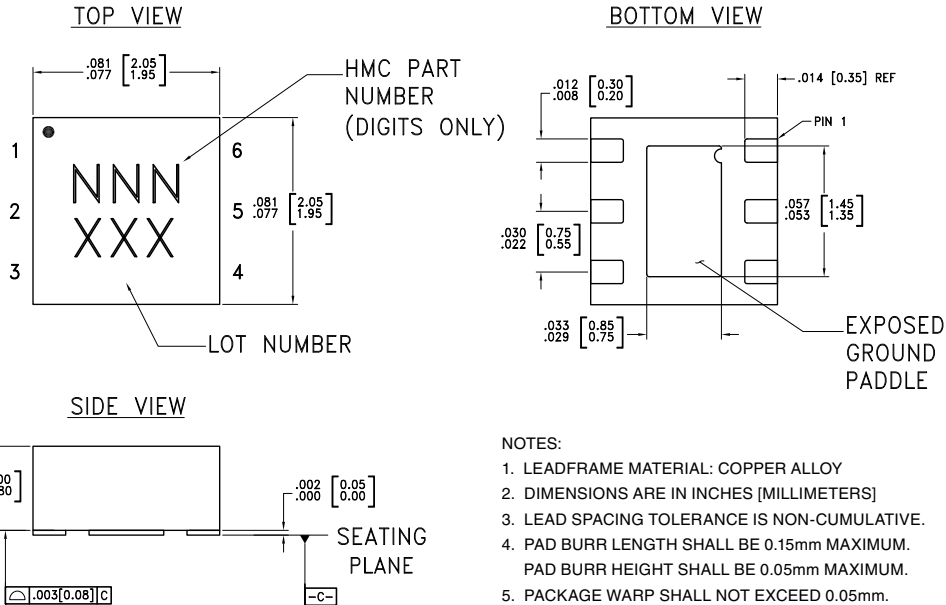



### Package Information

Part Number	Package Body Material	Lead Finish	MSL Rating	Package Marking <sup>[3]</sup>
HMC656LP2 through HMC658LP2	Low Stress Injection Molded Plastic	Sn/Pb Solder	MSL1 <sup>[1]</sup>	NNN XXX
HMC656LP2E through HMC658LP2E	RoHS-compliant Low Stress Injection Molded Plastic	100% matte Sn	MSL1 <sup>[2]</sup>	NNN XXX

[1] Max peak reflow temperature of 235 °C  
 [2] Max peak reflow temperature of 260 °C  
 [3] 3-Digit lot number XXX

### Pin Descriptions

Pin Number	Function	Description	Interface Schematic
1, 3, 4, 6	GND	Package bottom must be connected to RF/DC ground.	
2, 5	RF1, RF2	This pin is DC coupled and matched to 50 Ohms. Use DC Blocking capacitors if the input / output signals have non-zero DC potential	

## WIDEBAND FIXED ATTENUATOR FAMILY, DC - 25 GHz HMC656LP2E / HMC657LP2E / HMC658LP2E

### Evaluation PCB

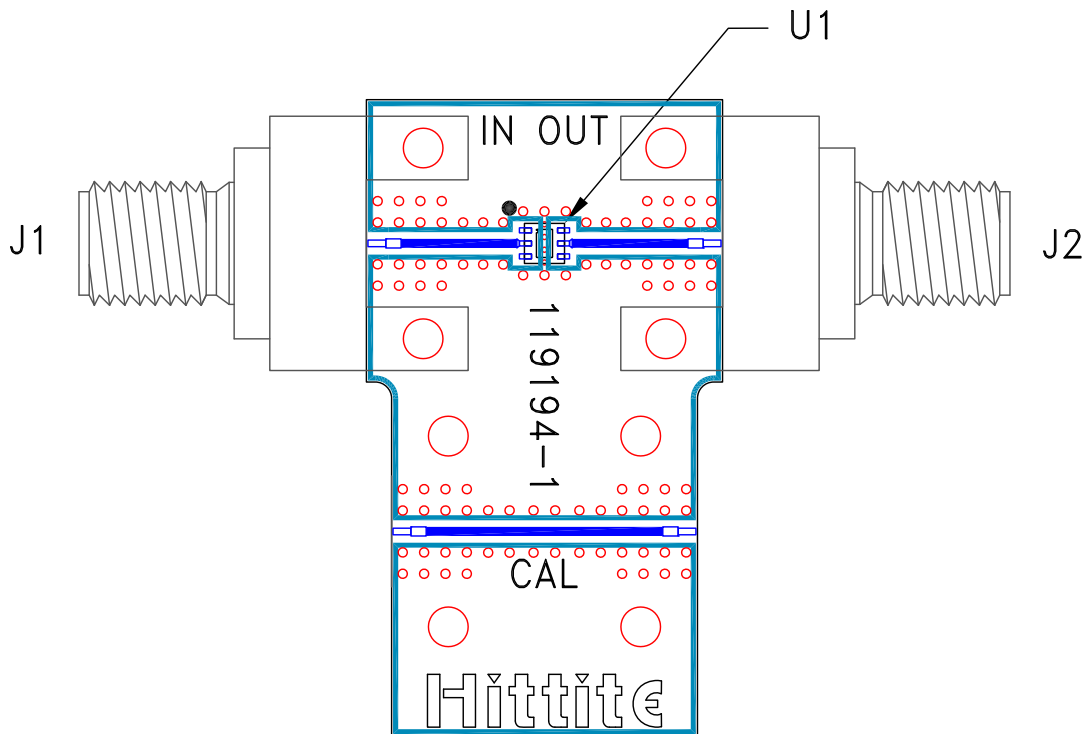

12

PASSIVES - SMT

### List of Materials for Evaluation PCB 119197 [1]

Item	Description
J1 - J2	PCB Mount SMA Connector
U1	HMC656LP2E through HMC658LP2E Passive Attenuator
PCB [2]	119194 Evaluation PCB

[1] Reference this number when ordering complete evaluation PCB

[2] Circuit Board Material: Rogers 4350

The circuit board used in the final application should be generated with proper RF circuit design techniques. Signal lines at the RF port should have 50 ohm impedance and the package ground leads and exposed paddle should be connected directly to the ground plane similar to that shown above. The evaluation circuit board shown above is available from Hittite Microwave Corporation upon request.