

Typical Applications

Prescaler for DC to 18 GHz PLL Applications:

- Point-to-Point / Multi-Point Radios
- VSAT Radios
- Fiber Optic
- Test Equipment
- Military

Functional Diagram

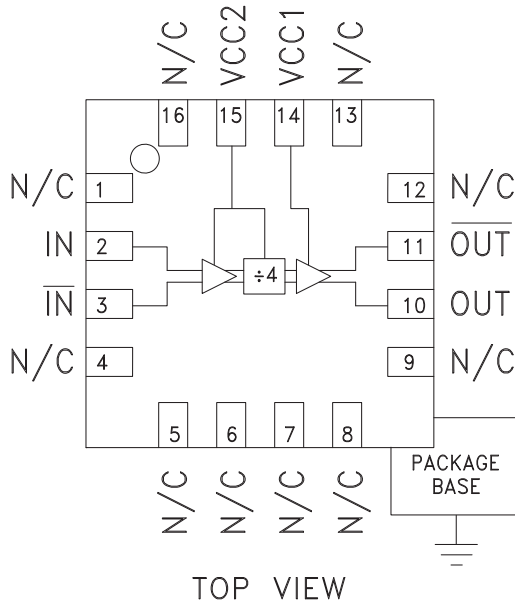

Features

- Ultra Low SSB Phase Noise: -150 dBc/Hz
- Very Wide Bandwidth
- Output Power: -4 dBm
- Single DC Supply: +5V
- 3x3 mm QFN SMT Package

General Description

The HMC493LP3 & HMC493LP3E are low noise Divide-by-4 Static Dividers utilizing InGaP GaAs HBT technology packaged in leadless 3x3 mm QFN surface mount plastic packages. This device operates from DC (with a square wave input) to 18 GHz input frequency from a single +5V DC supply. The low additive SSB phase noise of -150 dBc/Hz at 100 kHz offset helps the user maintain excellent system noise performance.

Electrical Specifications, $T_A = +25^\circ \text{C}$, 50 Ohm System, $V_{CC} = +5V$

Parameter	Conditions	Min.	Typ.	Max.	Units
Maximum Input Frequency		18	18.5		GHz
Minimum Input Frequency	Sine Wave Input. [1]		0.2	0.5	GHz
Input Power Range	$F_{in} = 2$ to 12 GHz	-20	-15	+10	dBm
	$F_{in} = 12$ to 14 GHz	-20	-15	+3	dBm
	$F_{in} = 14$ to 16 GHz	-20	-15	0	dBm
	$F_{in} = 16$ to 18 GHz	-15	-10	0	dBm
Output Power	$F_{in} = 0.5$ to 18 GHz	-7	-4		dBm
Reverse Leakage	Both RF Outputs Terminated		55		dB
SSB Phase Noise (100 kHz offset)	$P_{in} = 0$ dBm, $F_{in} = 6$ GHz		-150		dBc/Hz
Output Transition Time	$P_{in} = 0$ dBm, $F_{out} = 882$ MHz		100		pSec
Supply Current ($I_{cc1} + I_{cc2}$)			96		mA

1. Divider will operate down to DC for square-wave input signal



Input Sensitivity Window, $T = 25\text{ }^{\circ}\text{C}$

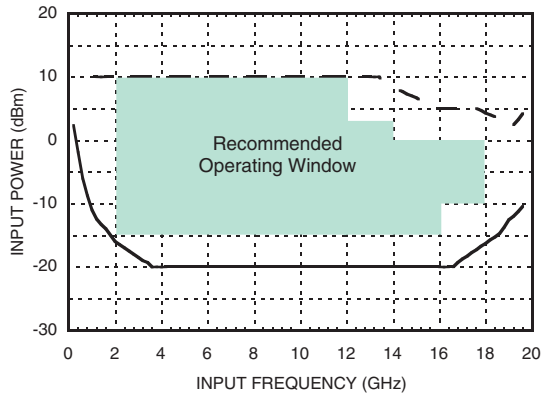

Input Sensitivity Window vs. Temperature

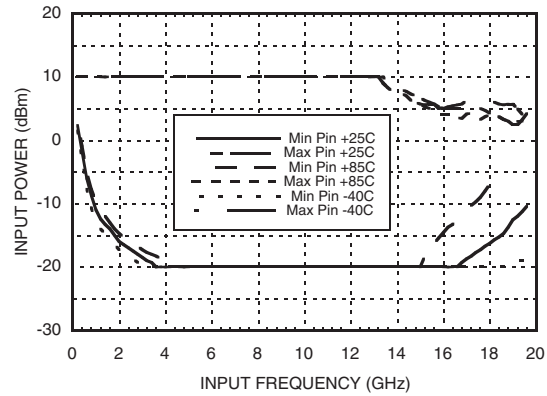

Output Power vs. Temperature

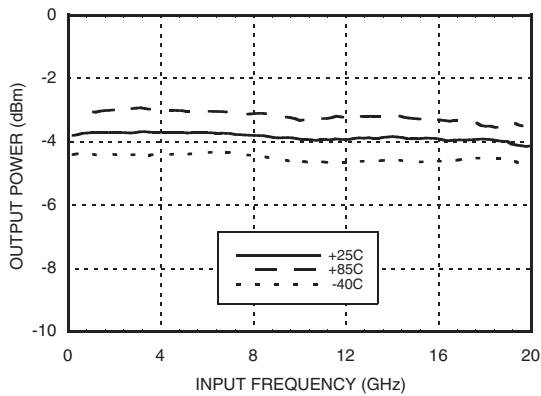

SSB Phase Noise Performance, $P_{in} = 0\text{ dBm}$, $T = 25\text{ }^{\circ}\text{C}$

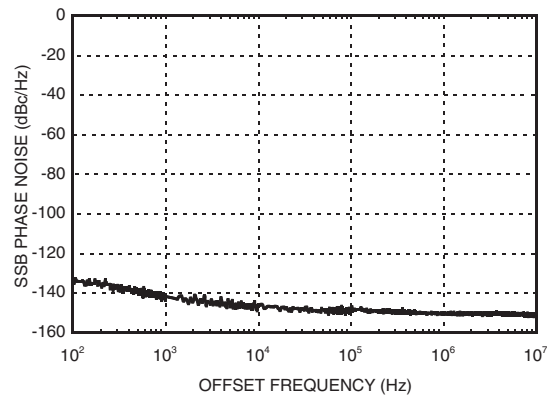

Output Harmonic Content, $P_{in} = 0\text{ dBm}$, $T = 25\text{ }^{\circ}\text{C}$

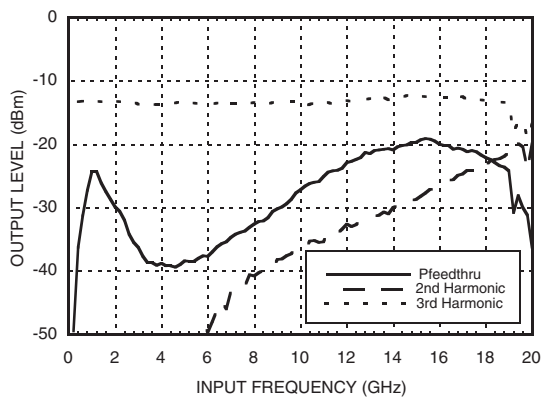

Reverse Leakage, $P_{in} = 0\text{ dBm}$, $T = 25\text{ }^{\circ}\text{C}$

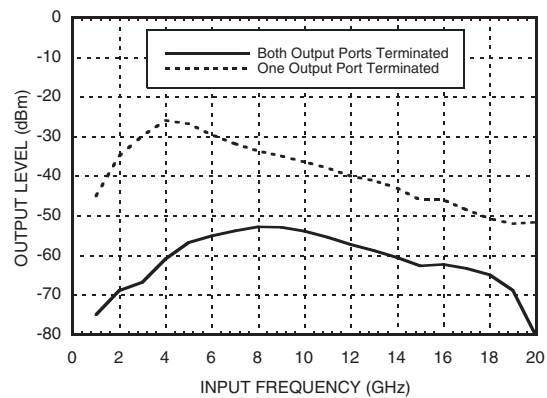



Output Voltage Waveform, Pin= 0 dBm, Fout= 882 MHz, T= 25 °C

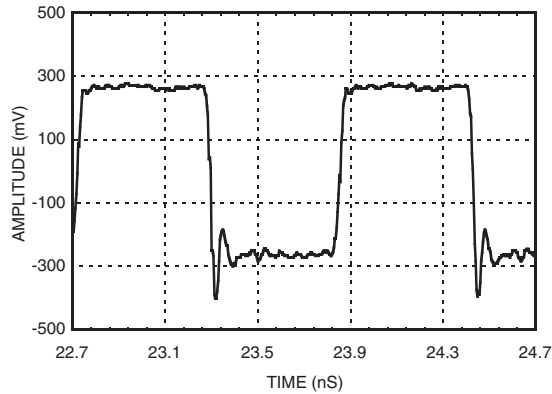

**ELECTROSTATIC SENSITIVE DEVICE
OBSERVE HANDLING PRECAUTIONS**

Absolute Maximum Ratings

RF Input (Vcc = +5V)	+13 dBm
Supply Voltage (Vcc1, Vcc2)	+5.5V
Channel Temperature (Tc)	135 °C
Continuous P _{diss} (T = 85 °C) (derate 11.9 mW/°C above 85 °C)	593 mW
Thermal Resistance (R _{TH}) (junction to ground paddle)	84 °C/W
Storage Temperature	-65 to +150 °C
Operating Temperature	-40 to +85 °C
ESD Sensitivity (HBM)	Class 1A

Typical Supply Current vs. Vcc

Vcc1, Vcc2 (V)	I _{cc} (mA)
4.75	84
5.0	96
5.25	108

Note: Divider will operate over full voltage range shown above

Outline Drawing

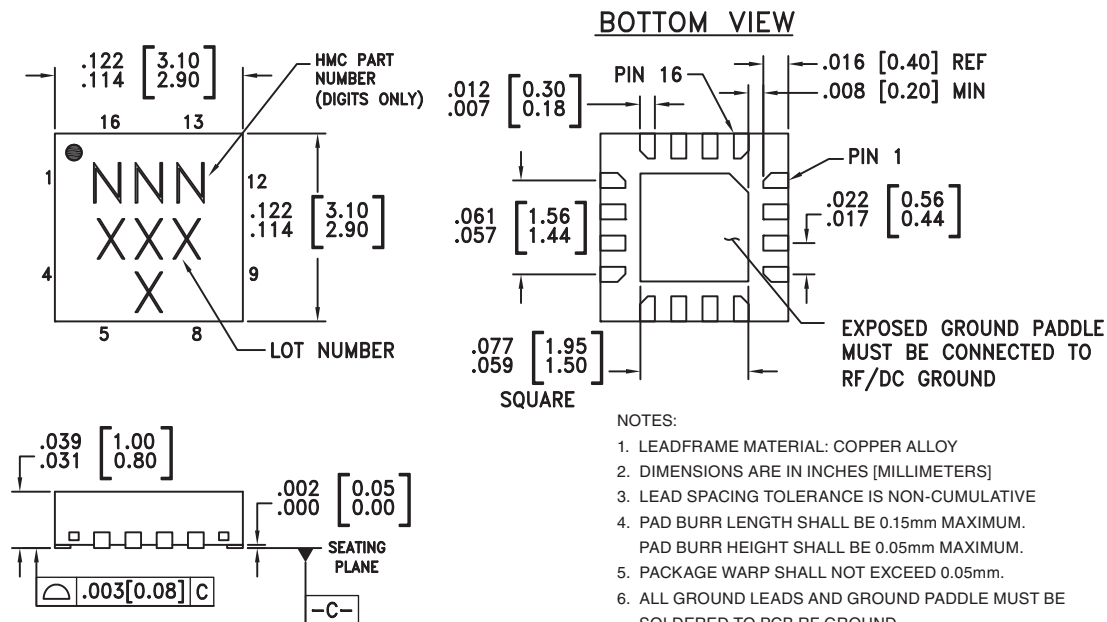

Package Information



Part Number	Package Body Material	Lead Finish	MSL Rating	Package Marking ^[3]
HMC493LP3	Low Stress Injection Molding Plastic	Sn/Pb Solder	MSL1 ^[1]	493 XXXX
HMC493LP3E	RoHS-compliant Low Stress Injection Molding Plastic	100% matte Sn	MSL1 ^[2]	493 XXXX

[1] Max peak reflow temperature of 235 °C

[2] Max peak reflow temperature of 260 °C

[3] 4-Digit lot number XXXX

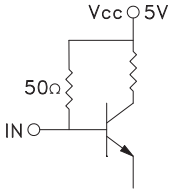
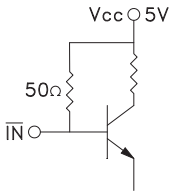
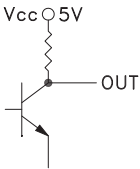
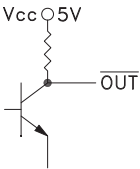
Pin Description

Pin Number	Function	Description	Interface Schematic
1, 4-9, 12, 13, 16	N/C	No connection.	
2	IN	RF Input must be DC blocked.	
3	$\overline{\text{IN}}$	RF Input 180° out of phase with pin 2 for differential operation. AC ground for single ended operation.	
10	OUT	Divided Output.	
11	$\overline{\text{OUT}}$	Divided output 180° out of phase with pin 10.	
14, 15	Vcc1, Vcc2	Supply voltage 5V ± 0.25V. Connect both pins to +5V supply.	
	GND	Ground: Backside of package has exposed metal ground slug which must be connected to RF/DC ground.	

Evaluation PCB

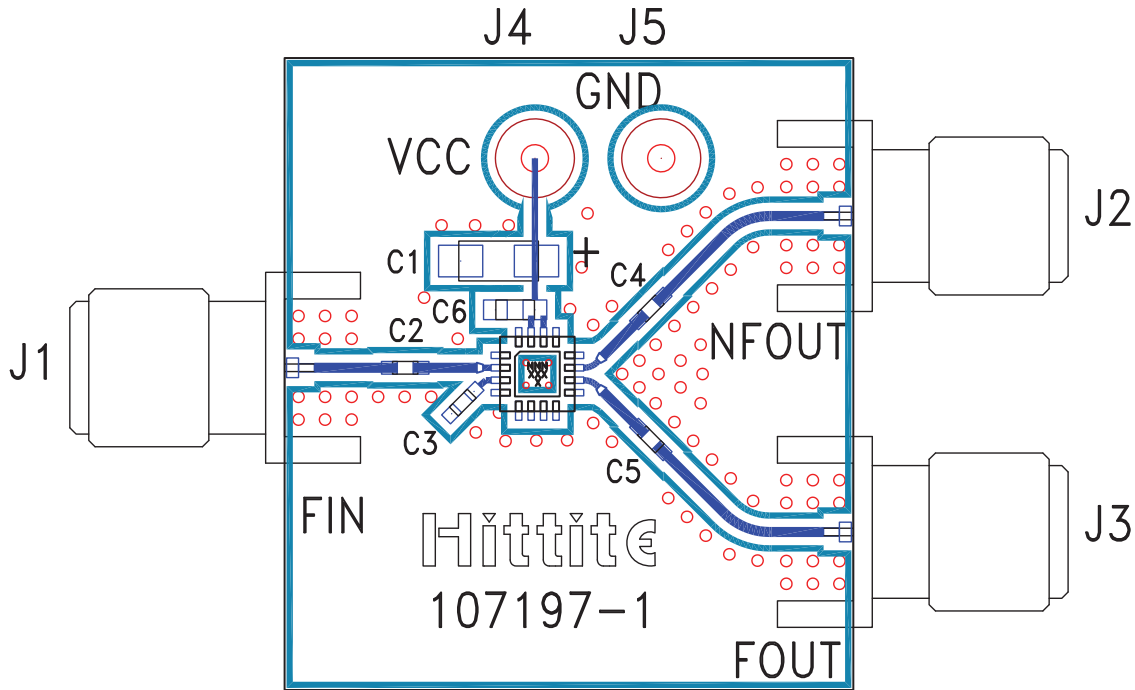

List of Materials for Evaluation PCB 107384 [1]

Item	Description
J1 - J3	PCB Mount SMA RF Connector
J4, J5	DC Pin
C2 - C5	100 pF Capacitor, 0402 Pkg.
C6	1000 pF Capacitor, 0603 Pkg.
C1	2.2 uF Tantalum Capacitor
U1	HMC493LP3 / HMC493LP3E Divide-by-2
PCB [2]	107197 Eval Board

[1] Reference this number when ordering complete evaluation PCB

[2] Circuit Board Material: Rogers 4350

The circuit board used in the final application should use RF circuit design techniques. Signal lines should have 50 ohm impedance while the package ground leads and backside ground slug should be connected directly to the ground plane similar to that shown. A sufficient number of via holes should be used to connect the top and bottom ground planes. The evaluation circuit board shown is available from Hittite upon request. This evaluation board is designed for single ended input testing. J2 and J3 provide differential output signals.

Application Circuit

